

Ermittlung der Bestellmaße

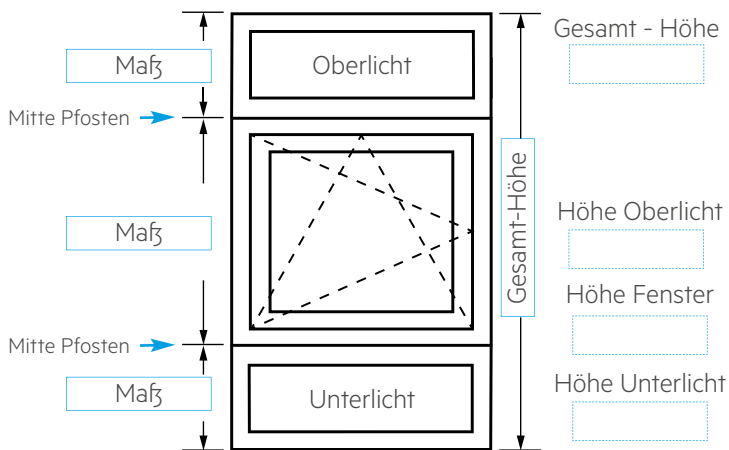

Ermittlung der Breite

Zwischen den Laibungen montiert

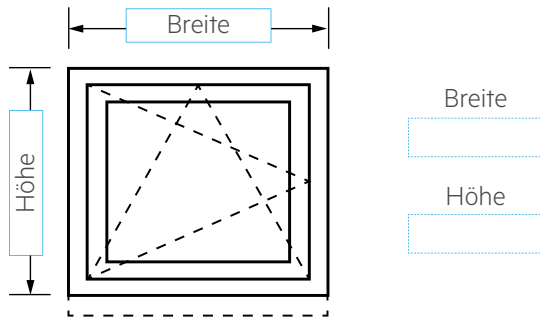
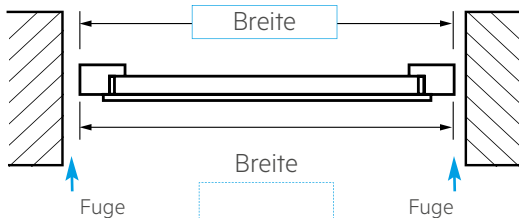

Im Anschlag montiert

Rahmenanschlag maximal 5 cm

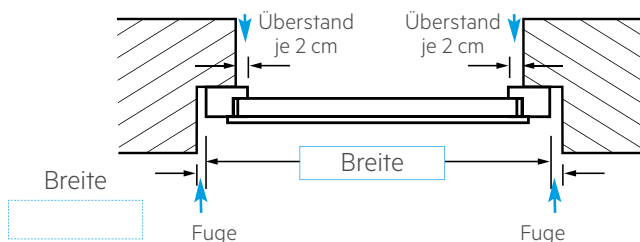

Ermittlung der Höhe

Neubau

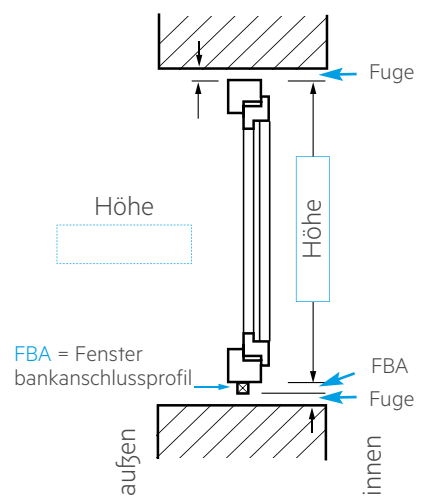

Renovierung

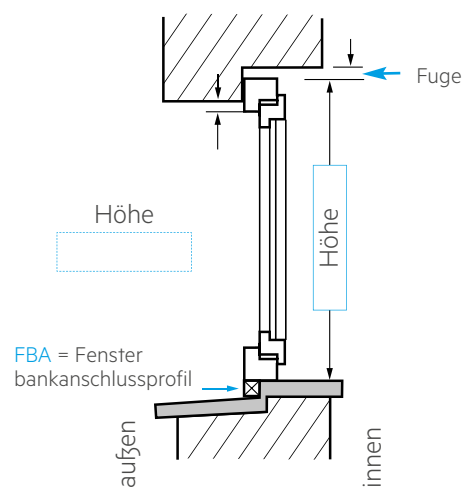

Ermittlung der DIN-Richtung

DIN-Rechts

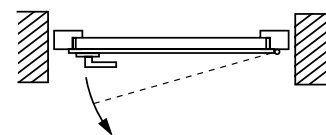

DIN-Links

